



## INTERNATIONAL APPLICATION PUBLISHED UNDER THE PATENT COOPERATION TREATY (PCT)

(51) International Patent Classification <sup>5</sup> : B03C 5/02, G01N 33/58	A1	(11) International Publication Number: <b>WO 94/16821</b> (43) International Publication Date: 4 August 1994 (04.08.94)
<p>(21) International Application Number: PCT/GB94/00121</p> <p>(22) International Filing Date: 21 January 1994 (21.01.94)</p> <p>(30) Priority Data: 9301122.9 21 January 1993 (21.01.93) GB</p> <p>(71) Applicant (for all designated States except US): SCIENTIFIC GENERICS LIMITED [GB/GB]; King's Court, Kirkwood Road, Cambridge CB4 2PF (GB).</p> <p>(72) Inventors; and</p> <p>(75) Inventors/Applicants (for US only): PARTON, Adrian [GB/GB]; 6 Swan Grove, Exning, Suffolk CB8 7HX (GB). HUANG, Ying [CN/US]; University of Texas, M.D. Anderson Cancer Center, Department of Experimental Pathology, 15125 Holcombe Boulevard, P.O. Box 89, Houston, TX 77030 (US). WANG, Xiao-Bo [CN/US]; University of Texas, M.D. Anderson Cancer Center, Department of Experimental Pathology, 15125 Holcombe Boulevard, P.O. Box 89, Houston, TX 77030 (US). PETHIG, Ronald [GB/GB]; Lley, Telford Road, Menia Bridge, Gwynedd LL59 5DT (GB). MacGREGOR, Alastair, Roy [GB/GB]; Field House, Thriplow Road, Fowlmere, Royston, Hertfordshire SG8 7QT (GB). POLLARD-KNIGHT, Denise, Vera</p>	<p>[GB/GB]; 20 Highfield Hall, Highfield Lane, St. Albans AL4 0RL (GB).</p> <p>(74) Agent: SMART, Peter, John; W.H. Beck, Greener &amp; Co., 7 Stone Buildings, Lincoln's Inn, London WC2A 3SZ (GB).</p> <p>(81) Designated States: JP, US, European patent (AT, BE, CH, DE, DK, ES, FR, GB, GR, IE, IT, LU, MC, NL, PT, SE).</p> <p>Published <i>With international search report.</i></p>	
(54) Title: METHODS OF ANALYSIS/SEPARATION		
<p>(57) Abstract</p> <p>Particles are subjected to travelling wave field migration (TWFM) to migrate the particles over an array of microelectrodes. Altered particles are produced by treating original particles in such a way so as to alter their TWFM characteristics and the altered TWFM characteristics are employed for analysis and/or separation of the altered particles. The particles may be cells, bacteria, viruses, biomolecules or plastics microspheres. They may be altered by binding to a ligand such as a metal microparticle via a selective linking moiety such as an antibody/antigen or oligo-nucleic acid, or be physical or chemical treatments.</p>		

**FOR THE PURPOSES OF INFORMATION ONLY**

Codes used to identify States party to the PCT on the front pages of pamphlets publishing international applications under the PCT.

AT	Austria	GB	United Kingdom	MR	Mauritania
AU	Australia	GE	Georgia	MW	Malawi
BB	Barbados	GN	Guinea	NE	Niger
BE	Belgium	GR	Greece	NL	Netherlands
BF	Burkina Faso	HU	Hungary	NO	Norway
BG	Bulgaria	IE	Ireland	NZ	New Zealand
BJ	Benin	IT	Italy	PL	Poland
BR	Brazil	JP	Japan	PT	Portugal
BY	Belarus	KE	Kenya	RO	Romania
CA	Canada	KG	Kyrgyzstan	RU	Russian Federation
CF	Central African Republic	KP	Democratic People's Republic of Korea	SD	Sudan
CG	Congo	KR	Republic of Korea	SE	Sweden
CH	Switzerland	KZ	Kazakhstan	SI	Slovenia
CI	Côte d'Ivoire	LI	Liechtenstein	SK	Slovakia
CM	Cameroon	LK	Sri Lanka	SN	Senegal
CN	China	LU	Luxembourg	TD	Chad
CS	Czechoslovakia	LV	Latvia	TG	Togo
CZ	Czech Republic	MC	Monaco	TJ	Tajikistan
DE	Germany	MD	Republic of Moldova	TT	Trinidad and Tobago
DK	Denmark	MG	Madagascar	UA	Ukraine
ES	Spain	ML	Mali	US	United States of America
FI	Finland	MN	Mongolia	UZ	Uzbekistan
FR	France			VN	Viet Nam
GA	Gabon				

METHODS OF ANALYSIS/SEPARATION

5           The present invention relates to analytical methods based upon the observation of the migration of particles in response to an electric field.

10           By way of background, particles can be manipulated by subjecting them to travelling electric fields. Such travelling fields are produced by applying appropriate voltages to microelectrode arrays of suitable design. The microelectrodes have the geometrical form of parallel bars, which may be interrupted by spaces to form channels, as  
15 shown in figure 1 and may be fabricated using standard metal sputtering and photolithographic techniques as described by Price, Burt and Pethig, *Biochemica et Biophysica*, Vol.964, pp.221-230. Travelling electric fields are generated by applying voltages of suitable  
20 frequency and phases to the electrodes as described in a paper, title "Separation of small particles suspended in liquid by nonuniform travelling field", by Masuda, Washizu and Iwadore, *IEEE Transactions on Industry Applications*, Vol.IA-23, pp.474-480. Masuda and his coworkers describe  
25 how a series of parallel electrodes (with no channels) supporting a travelling electric field can, in principle, be used to separate particles according to their electrical charge and size (weight). Masuda et al have not however described a practical demonstration of such a particle  
30 separation method.

          In a paper entitled "Travelling-wave dielectrophoresis of microparticles" by Hagedorn, Fuhr, Müller and Gimsa (*Electrophoresis*, Vol.13, pp.49-54) a method is shown for  
35 moving dielectric particles, like living cells and artificial objects of microscopic dimensions, over

microelectrode structures and in channels bounded by the electrodes. The travelling field was generated by applying voltages of the same frequency to each electrode, with a 90° phase shift between neighbouring electrodes.

5

In "Electrokinetic behaviour of colloidal particles in travelling electric fields: Studies using Yeast cells" by Y Huang, X-B Wang and R Pethig J. Phys. D. Appl. Phys. 26 1993 1528-1535, an analysis supported by experiment is made of the "travelling-wave dielectrophoresis" (TWD) effect described by Hagedorn et al (paper cited above). The phenomenological equation

$$\mu = - \frac{2\pi e_m r^2}{3\lambda\eta} A^2(0) \operatorname{Im} [f(\epsilon_p^*, \epsilon_m^*)]$$

15

is developed by Huang et al, to show that the TWD velocity is a function of the square of the particle radius ( $r$ ), the square of the electric field strength ( $A(0)$ ), the periodic length of the travelling field ( $\lambda$ ), medium viscosity ( $\eta$ ) and the imaginary part of the Clausius-Mossotti factor  $f(\epsilon_p^*, \epsilon_m^*)$  defining the dielectric properties of the particle and the suspending medium in terms of their respective complex permittivities  $\epsilon_p^*$  and  $\epsilon_m^*$ . This equation provides, for the first time, a practical guide for the design of travelling wave electrode systems for the manipulation and separation of particles.

Although the phenomenon in question is usually termed "travelling wave dielectrophoresis", we have now demonstrated that this is something of a misnomer as the force which acts on the particles to produce translational movement is not the dielectrophoresis force but rather that which acts in electrorotation. This force is related to

30

the imaginary component of the polarisability of the particle within its surrounding medium. However, as is discussed in more detail below, particle migration only occurs for travelling wave frequencies which produce  
5 negative dielectrophoretic forces on the particle.  
(Dielectrophoretic forces are related to the real component of the polarisability of the particle within its surrounding medium.) These forces are responsible for lifting the particle away from the electrodes and the  
10 channel between the electrodes. We accordingly prefer to refer to the phenomenon called previously "travelling wave dielectrophoresis" by the name "travelling wave field migration" (TWFM). We have established that to obtain TWFM, two separate criteria have to be met. First, a  
15 frequency must be selected at which the dielectrophoresis force acting on the particles is negative, ie such as to repel the particles from the electrodes. This, we have found requires the real component of the dipole moment induced in the particles to be negative.

20

Second, the frequency selected has to be such that the imaginary component of the dipole moment induced in the particles is non-zero (whether positive or negative) to produce a force displacing the particles along the array of  
25 electrodes.

The present invention is based upon the observation that the TWFM characteristics of a particle (i.e. the direction and speed at which it moves under TWFM and the  
30 conditions including electrode layout and spacing, voltage, frequency and suspending medium under which TWFM is possible) can be altered by a selection of methods which affect the dielectric characteristics of the particle concerned.

35

The present invention provides a method of analysis or

-4-

separation comprising treating a particle to form an altered particle, which altered particle has TWFM properties distinct from those of the original particle, and producing translational movement of said altered particle by TWFM using conditions under which the movement of the altered particle is different from that which would be obtained using the original particle under identical conditions.

10           The particle may be of a size to be visible using a light microscope (a microscopic particle) or may be smaller (a sub-microscopic particle) and may be detected using labels such as luminescent, fluorescent and electromagnetic radiation absorbent labels.

15           Examples of the former type of particle include mammalian cells, plant cells, yeast cells, plastics microbeads, chromosomes undergoing meiosis and mitosis and oocytes, eg. of *Cryptosporidium*.

20           Examples of the second type would include bacterial cells, viruses, DNA or RNA molecules, proteins, other biomolecules, and chromosomes.

25           The nature of the treatment used to convert the original particle into an altered particle can vary widely according to the nature of the particle. The treatment may involve forming a complex between the particle and a ligand. In some cases, the complex may involve a linking moiety connecting the particle and the ligand. The complex may further include a label connected to said ligand, optionally via a second linking moiety. The complex may involve numerous ligands bound to the particle.

35           The choice of linking moiety will obviously depend on the nature of the particle and the ligand. For instance if

one wishes to capture a nucleic acid species (the ligand) on a plastics micro-sphere (the particle), the linking moiety will normally be chosen to be a nucleic acid or nucleic acid analogue oligomer having a sequence  
5 complementary to that of the ligand or a part thereof.

The linking moiety may be bound first to the particle and may then be a species having an affinity for the ligand. Preferably, said affinity for the ligand is a  
10 selective affinity such that the formation of the complex between the particle and the ligand is selective and provides at least a degree of identification of the ligand. Preferably, said affinity is highly specific and accordingly the said linking moiety bound to the particle  
15 which provides the selective affinity for the ligand may be an antibody or an antibody fragment having antibody activity, an antigen, a nucleic acid probe or a nucleic acid analogue probe having selective affinity for complementary nucleic acid sequences, or avidin or an  
20 avidin-like molecule such as strept-avidin.

Antibodies and antibody fragments having antibody properties are particularly preferred. There are known techniques suitable for coating antibodies on to the  
25 surface of particles such as plastics micro-beads which are well known to those skilled in the art. Antibody coated particles are capable of recognising and binding corresponding antigens which may be presented on micro-organism cells or some other ligand.

30 Methods are also known for binding oligo-nucleic acid probes to such micro-beads. Suitable techniques are by way of example described in PCT Application No. GB92/01526. Where the linking moiety is a nucleic acid probe or a  
35 nucleic acid analogue probe, the resulting particle will of course be suitable for recognising and binding

complementary nucleic acid sequences.

The ligand may be chosen to increase the visibility of the particle or otherwise improve its detectability as well as to alter its TWFM characteristics. For instance  
5 antibodies bearing fluorophores or chromophores may be bound to the particle so that the complex so formed can be distinguished from the starting particle by TWFM and detected by fluorescence or colour.

10

The label may be bound to said ligand either before, simultaneously with, or after the formation of the complex between the ligand and the particle. The label may comprise a second linking moiety carried by said label.  
15 Once again, it is preferred that the affinity for the ligand possessed by the second linking moiety is selective, preferably highly specific and the second linking moiety may also be an antibody, an antibody fragment having antibody activity, an antigen, a nucleic acid probe, a  
20 nucleic acid analogue probe, avidin or an avidin-like molecule. The use of a label of this nature may be desired to aid ready detection of the complex and/or where a complex between the particle and the ligand does not in itself possess sufficiently distinctive TWFM properties,  
25 thus the TWFM may be further altered by the inclusion in the complex of the label. To this end, the label may be a fluorophore or chromophore, or a micro-organism, a metal particle, a polymer bead or a magnetic particle. For use in connection with TWFM measurements, the label preferably  
30 has dielectric properties and is capable of acquiring a significant surface charge. A particularly preferred material is colloidal gold which is easily bound to antibodies (as said second species) to form a label. Antibodies bound to colloidal gold are commercially  
35 available and methods for binding antibodies to colloidal gold are for instance described in Geohegan W.D. et al



(1978) Immunol. Comm 7, pl. Other metal particles however may be employed, eg silver particles and iron particles.

The use of a label of the kind described above may be preferred even where a complex between the ligand and a particle possesses sufficiently distinctive TWFM properties to enable the formation of such a complex to be observed. A higher level of specificity may in certain cases be obtained by the use of a label in such a complex. Thus for instance, one may wish to distinguish a micro-organism expressing an antigen A from a micro-organism expressing antigens A and B. This may be accomplished by the use of micro-particles having as a linking moiety an antibody to A and a label having as it's moiety an antibody to B. The difference in the velocities of the labelled complex (between the micro-particle, the micro-organism and the label) and the unlabelled complex (between the micro-particle and the micro-organism) can be observed, and used to distinguish micro-organisms expressing antigen A only, from those expressing A and B.

The label may include a magnetic particle so that the label can be attracted to a magnet so as to concentrate complexes containing said label for easier observation. In some cases it may be possible to attract labelled complexes to a magnet and to wash away unlabelled particles so as to eliminate the background of particles bearing linking moieties but no ligand/label which would normally be present. Suitable magnetic labels for this purpose will include iron micro-particles bearing linking moieties such as antibodies. Such antibody coated iron particles are commercially available.

Labels for both cells and smaller particles can include fluorescent markers eg FITC or rhodamine, chromophores, luminescent markers or enzyme molecules which

can generate a detectable signal. Examples of the latter include luciferases and alkaline phosphatase. These markers may be detected using spectroscopic techniques well known to those skilled in the art. The label could be  
5 bound to the ligand either before, simultaneously with, or after the formation of the complex between the ligand and the particle. In the case of cell transfection, the cells may co-express a marker with the gene product. For example, the gene for firefly or bacterial luciferase may  
10 be co-transfected into the cells enabling the transfected cells to be visualised by a luminescent signal.

The alteration of the original particle need not involve the formation of a complex. For instance, the TWFM  
15 characteristics of a cell may be altered by heating or by treatment with a reagent which alters the porosity of the cell membrane. Accordingly, the alteration may be in the particle itself rather than or in addition to a change due to the physical presence of a ligand in a complex. Both  
20 effects may be present in combination. A ligand forming a complex with a particle may exert a physical effect on the TWFM properties and also by interaction with the particle bring about a change in the intrinsic TWFM properties of the particle.

25

The invention includes methods as described above carried out for analytical purposes and also such methods carried out for preparative or other purposes.

30 The methods according to the invention may be employed in a wide variety of analytical applications including separation and analysis of samples containing cells for example, bacterial, mammalian, yeast, and insect cells or virus particles, and, biological macromolecules. Current  
35 methods of separating cells, for example flow cell cytometry, require expensive instrumentation, skilled

operators and significant laboratory resources. The techniques also have limitations when there are many different cell populations to be separated and when the cells of interest represent less than a few percent of the total. For separation and analysis of modified biological molecules, or complexes between biological macromolecules, employed techniques include electrophoresis and chromatographic separation using gel-filtration or affinity chromatography. Although these, in some cases, provide adequate separation, for many applications they can be time consuming and have limited resolution. In addition, use of these methods can affect the equilibrium between biological complexes. For example, gel-filtration results in a significant dilution of the sample.

15

Methods described hereafter according to the present invention allow some or all of these drawbacks to be addressed.

20

Where in an analytical method according to the invention a complex between the particle and a ligand is produced, the ligand need not itself be the species to establish the presence, nature or quantity of which is the ultimate purpose of the analysis. Thus, the ligand may be a reagent in the analysis and the species of interest in the analysis may be another component of the complex, eg the linking moiety or the particle itself. Where a particle is altered by treatment with a reagent, it may be the particle or the reagent which is essentially to be studied.

30

The process of TWFM described previously has been carried out using an array of linear, parallel electrodes subjected to phased electric fields normally such that every fourth electrode along the TWFM path is in phase. This periodicity defines the effective wave length of the

35

travelling wave field produced. We have established that this wave length is optimally about ten times the average diameter of the particle to be moved under TWFM, eg from 5 to 20 times or more preferably 8 to 12 times said average diameter. For particles which are not roughly circular, it is the length in the direction transverse to TWFM movement which is of significance.

The electrodes may be formed, depending on the dimensions required, using any of the standard techniques for patterning and manufacturing microscopic structures. For example the electrodes can be produced by:

screen printing;

deposition of electrode material (eg by electroplating or sputter deposition) followed by one of the following patterning techniques:

direct writing using an electron beam followed by etching (eg wet chemical etching, dry plasma etching or focused ion beam etching);

writing by exposure through a photolithographically generated mask followed by etching - the mask may be generated for example by visible, ultra violet, X-ray or electron beam lithography;

excimer laser ablation;

patterning followed by deposition of the electrode material (as in the X-ray LIGA process).

The invention will be further described and

illustrated by the following description of apparatus and methodology with reference to the accompanying drawings in which:

5           Figure 1 shows an electrode layout and voltage phase relationships for use in producing TWFM;

          Figure 2 shows the possible patterns of movement of particles over the electrode array shown in Figure 1;

10

          Figure 3 shows a modified electrode array in which the electrode spacing varies along the array.

          Figure 4 shows a further modified electrode array in which the electrode spacing varies across the array;

15

          Figure 5 shows a further modified electrode array in which the electrode spacing varies both across and along the array;

20

          Figure 6 shows an electrode array in which the central channel present in the arrays shown in earlier figures is absent;

25           Figure 7 shows schematically the components of apparatus for carrying out methods according to the invention and gathering data therefrom;

          Figure 8 shows schematically a complex constituting an altered particle used in an embodiment of the invention;

30

          Figure 9 shows schematically a ternary complex constituting an altered particle used in an embodiment of the invention;

35

Figure 10 shows a further ternary complex constituting an altered particle used in an embodiment of the invention;

5 Figure 11 shows a further binary complex constituting an altered particle used in an embodiment of the invention;

10 Figure 12 shows a complex in which the particle is a chromosome constituting an altered particle for use in the invention;

15 Figure 13 shows an electrode array useful in determining frequencies and suspending media likely to produce satisfactory TWFM characteristics for a particle;

20 Figure 14 shows graphs illustrating the dielectric properties of live cells in a medium of conductivity of  $5 \times 10^{-4} \text{ S m}^{-1}$ ;

Figure 15 shows graphs illustrating the dielectric properties of live yeast cells;

25 Figure 16 shows graphs illustrating the dielectric properties of dead yeast cells in a similar medium.

30 Examples of electrode designs for achieving separation effects are shown in figures 1 to 6.

In figure 1, the array of electrodes is constituted by two parallel rows of electrodes, each electrode being rectangular and elongate transverse to the direction of extension of the rows. The two rows are separated by a gap of constant width and the separation between each pair of electrodes in each row is the same. The electrodes are thin

metal film electrodes on an insulating substrate, suitably  
gold electrodes printed on a glass slide. The separation  
between the rows is  $30\mu\text{m}$  and the pitch between groups of  
four electrodes in each row is  $80\mu\text{m}$ . A useful rule is that  
5 generally the said pitch defining the wave length of the  
travelling wave should be from 5 to 20 times the size of  
the particle, eg 8 to 12 times, most preferably 10 times.

As shown in Figure 2, the response of particles  
10 exposed to a travelling wave field of the kind described  
below can be varied. Particles can be collected on the  
electrodes, they can be induced to spin and they can be  
caused to travel along the gap between the rows or over the  
electrode rows. This last type of movement is TWFM. The  
15 type of motion produced depends upon the nature of the  
particle, the suspending medium, the electrode spacing and  
the field frequency.

In figure 3, the periodic length between electrodes  
20 varies, so as to bring into effect the parameter  $\lambda$  in the  
above equation. For example, a travelling wave moving from  
the top to bottom electrodes, will accelerate a particle  
moving upwards under TWFM. This may be used for example to  
produce more uniform resolution along the TWFM path,  
25 counteracting a natural tendency for resolution to increase  
with distance travelled. In figure 4 the channel width  
also varies, and this brings into play the variation of the  
field  $A(0)$  of the above equation. A particle moving under  
TWFM will be accelerated as a result of the field  
30 increasing as the channel width decreases. Thus, two  
particles of different size but otherwise similar physico-  
chemical properties will be spatially separated as they  
move along the channel. Particles of different dielectric  
properties could be suspended in suitable medium such that  
35 the factor  $\text{Im}[f(\epsilon_p^*, \epsilon_m^*)]$  in the above equation has a  
different sign for each particle. The particles would then

physically separate by moving in opposite directions under TWFM.

5 Figure 5 is an electrode design that combines the influence of  $\lambda$  and  $A(0)$ . Particles can also be induced to move over parallel electrodes under the influence of travelling fields, and an example of an electrode geometry where separation can be achieved using differential particle acceleration is shown in figure 6.

10

The particles will move under TWFM unless they are trapped by positive dielectrophoresis forces (as described in the work of Huang et al). This provides an extra facility for selectively trapping and separating particles according to their dielectric properties and size.

15

As shown in Figure 7, apparatus for use in accordance with the invention comprises a light microscope schematically indicated by a lens 100 which is equipped with a CCD camera attachment 102 as well as a conventional field illuminating light source 103 and slide carrier stage (not shown).

20

The CCD camera 102 is connected to a signal processor unit 104 and to a display screen 106. The apparatus further comprises a frequency generator 108 which in use is connected to terminals provided on a microscope slide 110 which bears a pattern of electrodes as shown in more detail in Figure 1.

30

The electrodes may be printed, eg in gold, or coated and etched on the microscope slide 110 together with tracks leading to terminals for connection to the frequency generator 108. The frequency generator provides the electrical field output. The frequency generator is provided with variable outputs to enable the operator to

35



set the frequency of the sine wave outputs and the peak to peak voltage of them.

In use, the image appearing on the display of the apparatus shows a number of beads within the field of the microscope migrating sufficiently slowly that the rate of migration within a period such as 30 seconds can be determined directly by an observer looking at each bead in turn. Whilst apparatus described above is sufficient to produce useful results as demonstrated by the specific examples given below, it is generally preferable that migration speed measurements be carried out on more beads than a human observer could reasonably deal with directly. For this purpose, it will be desirable to use image processing techniques to detect and measure the migration of the beads in the apparatus. From the CCD camera attachment, one may derive images of a field of view containing a number of migration beads. A series of such images, or frames, may be captured by frames-grabber circuitry in a computer and the series of the images may be analysed by image processing software.

Thus, a thresholding process may be used for example to convert the grey scale image produced by the camera into a binary image. A separate thresholding operation is performed to identify any areas of the image which are considered too dark, these areas being removed from the binary image of the beads. The remaining shapes in the image may be separated from the rest of the image and subjected to a test of one or more characteristic properties, such as area, to select those which are likely to represent beads. The centre of mass may then be determined for each qualifying shape. The positions of the centres may be compared between the successive frames in order that each bead in one frame may be located in the next. Once a bead has been located in two frames, the

difference in the position of the bead will give directly the migration distance from which its migration rate may be calculated and averaged over several pairs of frames. By such automated techniques the migration speeds of all of the beads within the field of view at any moment may be measured and a statistical picture of the migration characteristics of the beads may be developed, optionally using a number of field migration frequencies.

Other image processing techniques may also be used to identify the position of particles and to determine their movement, for example correlation, edge detection, or morphological techniques or images subtraction. Neural networks may also be used to identify particles.

It is not always necessary to use an imaging detector of the type described above to determine particle velocities. Alternative detection configurations include:

- light scatter detectors, as in a flow cytometer;
- standard fluorescence detection arrangements;
- luminescence detection using CCDs or other detectors;
- single or multi-element optical spectroscopic measurements;
- refractive index modulation detection (eg by phase contrast techniques);
- detection by acoustic impedance measurement (which is related to particle mass) using surface or bulk acoustic sensors;
- electrical impedance, capacitance, or inductance.

The apparatus may be further modified by the inclusion of a magnet, suitably an electro-magnet, positioned to draw any magnetic beads in the sample into the field of view of the microscope. The magnet would then be removed or turned  
5 off whilst the migration characteristics of the beads were measured. Alternatively, the particles may be manipulated into position by dielectrophoresis or electrophoresis.

As shown in Figure 8 a micro-particle may comprise a  
10 plastics bead 12 having bound to it as a linking moiety one or more antibody molecules 14. It should be noted that the drawing is not to scale and that normally in reality the plastics beads will be coated with a multitude of antibody molecules. The micro-particles may be exposed to micro-  
15 organism cells 16 bearing surface antigens reactive with the bound antibody to form a complex 10 between the micro-particle and the cell. The micro-organism cells may for instance be *E. coli* or coliforms present in water or pathogenic micro-organisms present in foodstuffs such as  
20 listeria or salmonella. It has been found that the rate of migration of such micro-particle/micro-organism cell complexes under suitably chosen conditions is distinguishable from the migration rates obtained using the micro-particles alone and furthermore that the migration  
25 rates obtained for complexes between micro-particles and viable micro-organism cells can be distinguished from those obtained between micro-particles and similar non-viable cells.

30 As shown in Figure 9, a ternary complex 10 may be produced between a micro-particle 12 of the kind shown in Figure 8 as described above, an antigen 18 and a label 20 comprising a labelling moiety 22 and a second antibody 24 which may be the same as or different from the antibody 14.  
35 A ternary complex of this type may be employed where the antigen 18 is too small or lacking in dielectric properties

sufficiently to affect the TWFM properties of the micro-particle 10 or where it is desired to obtain a higher level of specificity through the use of two different antibodies in a single analysis. The antigen may for instance be a  
5 toxin present as a contaminant in a foodstuff.

Figures 10 and 11 illustrate methods of detecting nucleic acids and in particular nucleic acid sequences produced as products of amplification procedures such as  
10 PCR, LCR and 3SR techniques. Known methods of detecting nucleic acid amplification procedure products rely upon them undergoing some form of purification and/or separation procedure before they are analysed. One commonly used method involves the analysis of the products by agarose gel  
15 electrophoresis. This separates the amplified DNA fragments and any remaining oligonucleotide primers on the basis of size. Separating products on the basis of size alone does not enable one to distinguish between PCR products of the required base sequence and an amplified  
20 contaminant of approximately the same length. In order to further identify PCR products, the gel electrophoresis may be taken one step further by subjecting its product to the Southern blotting technique in which the separated fragments are transferred from the gel to a membrane in  
25 direct correspondence to their relative positions on the gel. They are then probed with a labelled single stranded DNA probe with a base sequence complementary to the sequence of interest. The label used for the probe is usually biotin or a radio-isotope such as  $^{32}\text{P}$ . Southern  
30 blotting is relatively laborious and requires a moderate level of laboratory skill as well as laboratory equipment and facilities. It is not suited for use in rapid screening of a large number of samples or the screening of samples outside the laboratory. The method of dot blotting  
35 in which the agarose gel separation step of Southern blotting is omitted is somewhat quicker but basically

suffers from the same disadvantages as Southern blotting.

As illustrated in Figure 11, in a method according to the present invention a microparticle may include an  
5 oligonucleotide or synthetic oligonucleotide analogue as a capture probe 26 (linking moiety) bound to the surface of a polymer bead and having a sequence complementary to that of an expected amplification procedure product 28. A label 30 comprising an TWFM labelling moiety 32 as described above  
10 bound to a second oligonucleotide or oligonucleotide analogue sequence 34 complementary to a second region of the ligand nucleic acid sequence is employed. The microparticles and the label may be added to the product of the amplification reaction before or after any working up of  
15 the reaction mixture to separate the amplification products. The TWFM properties of the microparticle/amplification product/label ternary complex may then be observed and distinguished from those of the microparticles alone. A variant on this procedure is  
20 illustrated in Figure 8 in which one of the primers used in the amplification procedure is labelled with a suitable TWFM labelling moiety 32 which thereby becomes covalently incorporated into the nucleic acid product of the amplification procedure. A binary complex is then produced  
25 between a micro-particle bearing a capture probe 26 and the amplification product and the TWFM properties of the complex are observed.

In a variant of Figure 11 shown in Figure 12, the  
30 ligand nucleic acid may be a chromosome (complex nucleic acid) and the micro-particle may have discrete dielectric properties eg is metallic (gold) etc. This is particularly useful for the separation of human (and other species) chromosomes where different chromosomes may have  
35 similar sizes, and dielectric properties. Technologies such as flow cytometry are currently used to sort

-20-

chromosomes on a size basis, and are thus incapable of discriminating chromosomes of similar sizes. In the case of humans, chromosomes 9-12 inclusive can not readily be separated by flow cytometry due to their similar size.

5 According to our approach if these chromosomes are pre-labelled with a 'dielectric' marker they can be separated on the basis of their dielectric properties.

In practice this is achieved by partially denaturing  
10 the chromosomal DNA (by for example heat, chemical treatment, or electrical treatment), and subsequently hybridising a complementary (to a defined nucleic acid sequence) nucleic acid probe. The nucleic acid probe may preferably consist of at least 15 nucleotides, and may  
15 itself be pre-labelled with an entity which has an affinity for a binding agent. For example, but not exclusively, the label may be 'biotin' which can be incorporated into a nucleotide, or added to the terminal region of the probe sequence. The binding agent may be for example, an  
20 antibody which has specificity for the label, or alternatively a protein/enzyme etc which has an affinity for the label of choice. The binding agent may in turn be bound to a micro-particle which could as both a dielectric amplifier (by amplifying additional dielectric properties)  
25 and/or an aid to detection of the chromosomes of choice. Thus a complex could be envisaged as described in Figure 9. Following the 'dielectric labelling' of the ligand chromosome it can then be separated from the other chromosomes on the basis of different dielectric  
30 properties. Practically this may be achieved by using different migration frequencies, or selective electrode arrays - see Figures 1 to 3.

Thus it is possible to see that the selective  
35 separation and identification of chromosomes could be achieved using the method described above. This has

practical application in clinical diagnostics where, identification and characterisation of chromosome alterations, eg re-arrangements/dilutions, insertion of foreign DNA eg viral DNA is important.

5

Alternatively, the chromosome may be the particle and it may be treated by hybridisation thereto of a nucleic acid probe bearing a label (the ligand) which alters the TWFM characteristics of the chromosome and optimally which also aids its detection, eg a fluorescent marker.

10

In order to observe TWFM for an altered particle which is distinct from the behaviour of the unaltered particle under identical conditions, one needs to select the conditions with care. It has been established that in order for TWFM to occur, the particles need to be repelled from the electrodes so as to be levitated above the electrodes and not drawn down onto the electrodes. Simultaneously, the particles need to be propelled along the electrode array by the electric field travelling wave. The dielectrophoresis force responsible for the repulsion or attraction of the particles to the electrodes is determined by the real component of the induced dipole moment in the particle. The propulsion of the particle along the electrode array is determined by the magnitude of the imaginary component of the induced dipole moment and the direction of movement by its sign. Both of these real and imaginary components vary with field frequency and depend also on the nature of the particle and the suspending medium. To produce a visible difference in behaviour between the altered and unaltered particles one needs to find field conditions and suspending medium characteristics in which the relationship between the real and imaginary components of the dipole moment are adequately different for the two forms of the particle. This can be done as follows.

35

Particles for which characteristics are to be determined are suspended in a chosen medium and are pipetted into a chamber having at its base an array of electrodes as shown in Figure 13. A rotating electric field is applied to the electrode array and the frequency of the rotating field is scanned stepwise over a desired range, eg. from 10 to  $10^{10}$  Hz. At each frequency the angular velocity and sense of the electrorotation produced in the particles is noted as a measure of the imaginary component of the induced dipole moment. This is plotted as the line TRANS in Figure 14. The line DEP representing the dielectrophoretic force experienced by the particles can either be computed from the line TRANS taking into account the complex polarisability of the particles or experimentally determined in the same apparatus. For the latter, the electrodes are subjected to a field such that adjacent electrodes have a sinusoidal voltage phased  $180^\circ$  apart. The speed at which the particles move away from the central area between the electrodes (positive DEP effect) or move towards the central area (negative DEP effect) is plotted against frequency.

A typical result for a live cell such as an erythrocyte or yeast cell is seen in Figure 14. The shape of curve is typical of live cells, the frequencies will vary with cell type. TWFM will be seen in the two areas  $f_1-f_2$  and  $f_3-f_4$  where the dielectrophoresis (DEP) is negative so that the particles are repelled up from the electrodes, and the interaction with the travelling wave produces a net force along the electrode array (non-zero TRANS). The direction in which the particles move depends on whether TRANS is positive or negative.

Actual curves for live and killed yeast cells are shown in Figures 15 and 16. It can be seen that the TWFM region between  $f_1$  and  $f_2$  is present only for live cells.



Accordingly, the killed (i.e. altered) cells will remain stationary whilst the original cells will migrate under these frequency conditions.

5           The conductivity of the suspending medium will affect the shape of the curves plotted as in figures 14 to 16. The conductivity may be adjusted empirically to obtain suitably shaped curves.

10           The frequency range illustrated will often be found most convenient but there may be other TWFM areas beyond this range in one or both directions that may be employed.

#### Example 1

15

Selective Manipulation and Separation of Untreated and Heat-treated Yeast Cells.

20           Baker's yeast cells (*Saccharomyces cerevisiae*, strain RXII, obtained from the Department of Biophysics, Free University, Berlin) were grown at 30°C in an aqueous medium consisting of sucrose (50 g/l), yeast extract (5 g/l) and peptone (5 g/l). Growth curves for the yeast culture were obtained by measuring the change in optical absorbance of  
25           the yeast suspension during its batch culture using a double beam spectrophotometer. When the cells had reached the stationary phase of growth, they were harvested and washed four times in 280 mM mannitol. The cells were  
30           rendered non-viable by heating to 90°C in a waterbath for 20 minutes, after which they were washed as before in 280 mM mannitol.

35           Cell viability was determined using a methylene blue stain. The stain was prepared from three stock solutions comprising: [1] Methylene blue (0.250g/l) in 20ml of distilled water, [2]  $\text{KH}_2\text{PO}_4$  (2.722g) in 100ml of distilled

water, [3]  $\text{Na}_2\text{HPO}_4$  (0.248g) in 10ml of distilled water. A working solution was prepared by mixing 2ml of [1], 99.7ml of [2] and 0.25ml of [3]. No less than 0.02ml yeast of suspension was mixed with 0.8ml suspension medium plus  
5 0.08ml of methylene blue. Non-viable cells took up the blue dye into the cytoplasm and could be differentiated from the live cells, which excluded the dye from their interiors. Suspensions with different relative amounts of viable and non-viable cells were made by mixing, were made  
10 in 280 mM mannitol having electrical conductivities (adjusted by adding NaCl) of 1, 10 and 50 mS/m as determined at 50 kHz using platinum black electrodes and a HP 4192A impedance analyser.

15 50 microliter samples of such suspensions were pipetted on to a microelectrode array of the same form of figure 1, fabricated using standard photolithography and of geometry and electrical connections as described by Huang, Wang, Tame and Pethig in their paper "Electrokinetic  
20 behaviour of colloidal particles in travelling electric fields: studies using yeast cells" J.Phys. D:Appl.Phys.26 (1993) 1528-1535, so as to subject the cells to the forces exerted by travelling electric fields. The electrode widths were of nominal dimension 14 microns, the gap  
25 between adjacent electrodes was of the order 6 microns, and the distance across the channel between opposing electrode tips was 30 microns. The voltage phase relationships were as shown in figure 1, so that the effective periodic length  $\lambda$  of the travelling field was 80 microns. These dimensions  
30 were chosen to provide the most selective TWFM effects for particles such as yeast cells which have an average diameter of the order 6 to 8 microns. The travelling electric fields were established by sequentially addressing the electrodes with sinusoidal voltages of phase separation  
35 as shown in figure 1, and the amplitude of the applied voltages was 5 V (peak-peak). A cover slip was placed over

the suspension and the resulting motions of the cells were viewed through a microscope.

On examining the TWFM of the viable yeast cells at a  
5 suspending medium conductivity of 1 mS/m the viable cells  
did not exhibit TWFM at all the frequencies investigated  
between 1 kHz and 10 MHz, and remained trapped at the  
electrode edges and tips. For a medium conductivity of 10  
mS/m the viable cells exhibited TWFM in the frequency range  
10 between 8 kHz and 60 kHz and in so doing moved along the  
channel between the electrode tips in a direction *opposing*  
that of the imposed travelling field. For a medium  
conductivity of 50 mS/m, the viable cells exhibited TWFM  
between 3 kHz and 300 kHz, again moving along the channel  
15 in the *opposite* sense to that of the imposed travelling  
field. The behaviour of the non-viable cells, identified  
by their blue staining, was however significantly  
different. For a suspending medium conductivity of 1 mS/m,  
the non-viable cells remained trapped at the electrodes at  
20 all frequencies from 1 kHz to 2 MHz, but between 3 MHz and  
10 MHz they exhibited TWFM and moved along the channel in  
the *same* direction as the travelling field. Thus, for a  
medium conductivity of 1 mS/m, the non-viable cells could  
be selectively removed from the viable cells in the cell  
25 mixture, by applying a travelling field of frequency 3 MHz.  
For a medium conductivity of 10 mS/m, the non-viable cells  
exhibited TWFM only for frequencies above 3 MHz, and in so  
doing travelled along the channel in a direction *opposing*  
that of the travelling field. Thus, at 10 mS/m  
30 conductivity of the suspending medium, by applying a signal  
frequency of 30 kHz, the viable cells were selectively  
moved down the channel in a direction *opposing* the  
travelling field, whilst for a frequency of 5 MHz the non-  
viable cells were selectively move along the channel in the  
35 *same* direction as the travelling field. By applying a 30  
kHz travelling field to the electrodes at the same time and

in the same direction as a 5MHz travelling field, evidence was obtained for the possibility of moving both the viable and non-viable cells down the channel and over the electrodes at the same time and in opposite directions so as to facilitate their complete separation from each other. At a medium conductivity of 50 mS/m, the non-viable yeast cells exhibited a relatively weak TWFM in the frequency range between 70 kHz and 700 kHz, and they travelled along the channel in the opposite direction to that of the travelling field. Thus at a medium conductivity of 50 mS/m, by applying a travelling field frequency of 50 kHz, the non-viable cells remained trapped at the electrodes, whilst the viable ones travelled down the channel in a direction opposing that of the travelling field. By superimposing another travelling field at 500 kHz and in the opposite direction to that of the 50 kHz travelling field, an indication of the non-viable cells moving in the opposite direction to that of the viable cells was observed, but this separation effect was not as large as that observed for a medium conductivity of  $10 \text{ mS}^{-1}\text{m}$  for superimposed fields of 30 kHz and 5 MHz.

These results demonstrate the capability of selectively identifying and separating "treated" particles from "non-treated" particles, and provide guidance in the principles involved in choosing the most effective conductivity of the suspending medium (liquid or gel) and of the frequency or frequencies, and direction, of the applied travelling field or fields.

Further examples of analyses and separations possible using the techniques of the invention are as follows.

A double stranded DNA molecule having attached to it a protein such as a transcription factor (altered particle) may be separated from DNA lacking the protein by selecting

conditions under which only the altered particle migrates and the protein may then be cleaved off isolated, sequenced and studied.

5 In a variant of the above the protein-DNA complex may be separated from similar protein-DNA complexes to which an additional protein has bound (altered particle).

10 A cell having on its surface a receptor for a ligand such as an antibody, growth factor, neurotransmitter or other biochemical messenger may be separated from similar cells to which the appropriate ligand has bound.

15 Cells which have been successfully transfected such that they express a new gene product, possibly located in the cell membrane, may be differentiated from the original form of cell.

20 Cells to which a phage has bound may be differentiated from non-infected cells.

25 Cells may have an oligonucleotide probe bound to a label such as a gold particle introduced into them to bind to complementary genomic DNA during cell division to separate dividing from non-dividing cells.

30 Methods of detection used are not limited to microscopy. For instance, where the altered particle includes a dye or fluorescent marker, the presence of altered particles may be monitored by an appropriate spectrophotometer.

35 The electrodes need not be arranged as a linear "ladder". Instead the "ladder" of electrodes may be curved or otherwise non-linear. It may form a spiral or serpentine path or may be a closed path around which the

particles travel.

CLAIMS:

- 5 1. A method of analysis or separation comprising treating a particle to form an altered particle, which altered particle has field migration properties distinct from those of the original particle, and producing translatory movement of the altered particle and/or of the original  
10 particle by travelling wave field migration (TWFM) using conditions such that the movement of the altered particle under the said conditions differs from that of the original particle under the same conditions.
- 15 2. A method as claimed in claim 1, wherein the particle is observable by use of a light-microscope.
3. A method as claimed in claim 1, wherein the particle is too small to be observed by the use of a light-  
20 microscope.
4. A method as claimed in any preceding claim, wherein the altered particle is formed from the original particle by treatment comprising forming a complex between said  
25 original particle and a ligand.
5. A method as claimed in claim 4, wherein said complex includes a linking moiety connecting said particle and said  
ligand.
- 30 6. A method as claimed in claim 5, wherein said complex further includes a label connected to said ligand.
7. A method as claimed in claim 6, wherein said label is  
35 connected to said ligand via a second linking moiety.

8. A method as claimed in any one of claims 1 to 3, wherein said altered particle is produced by a treatment which alters the intrinsic dielectric properties of the original particle.

5

9. A method as claimed in any preceding claim wherein the effective wavelength of the travelling field is from 8 to 12 times the size of the altered particle as measured transverse to the direction of movement under TWFM.

10

10. An electrode array for use in TWFM comprising a row of electrodes the spacing between successive one of which progressively increases.

15

11. An electrode array for use in TWFM comprising two separated rows of electrodes the spacing between which rows progressively increases.



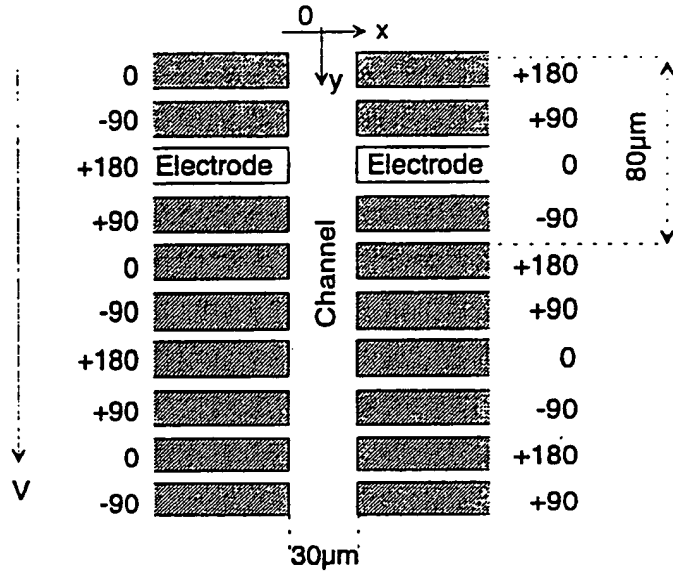

Figure 1

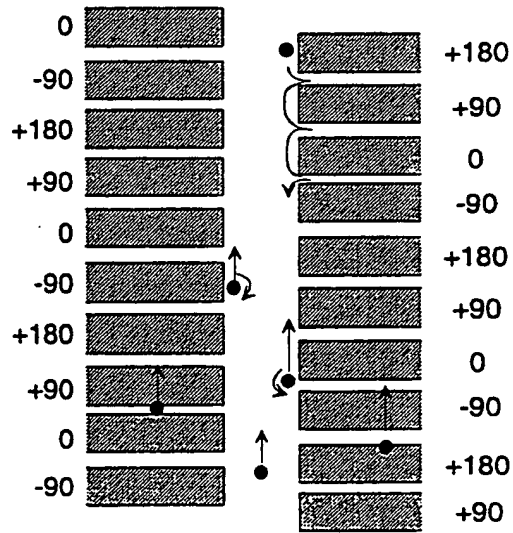

Figure 2

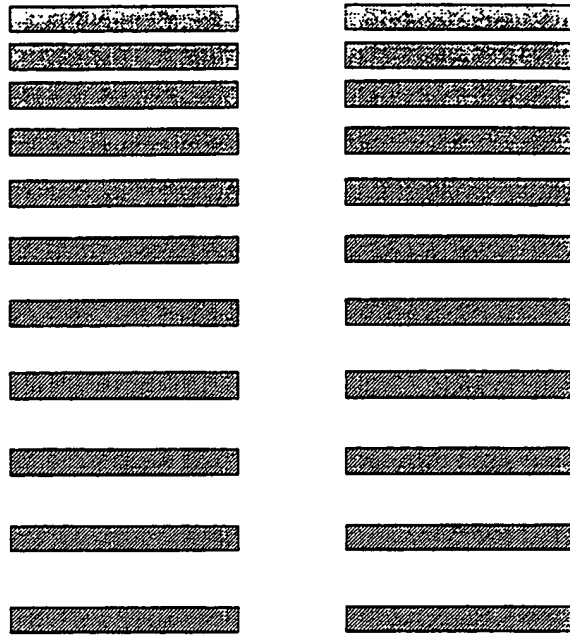

Figure 3

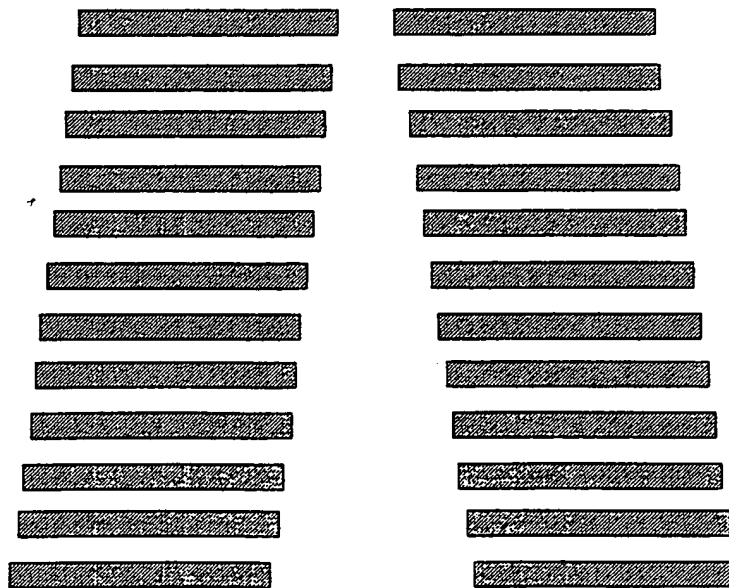

Figure 4

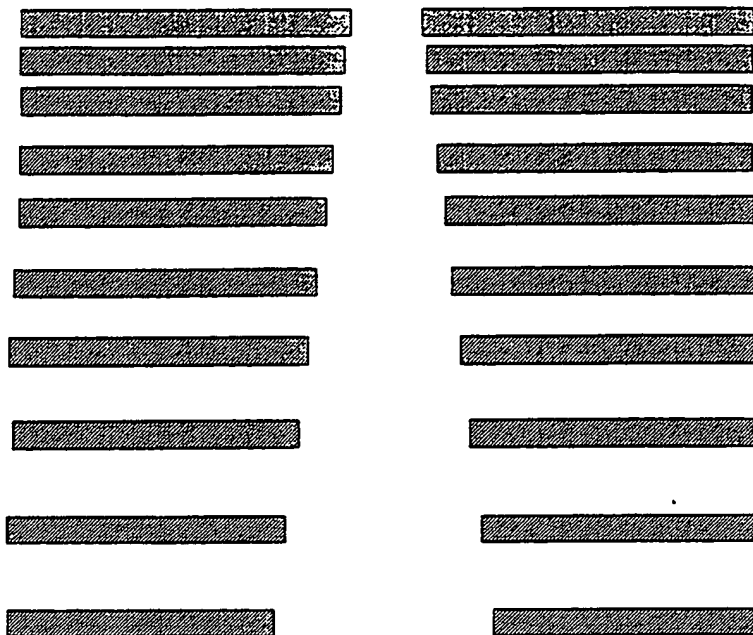

Figure 5

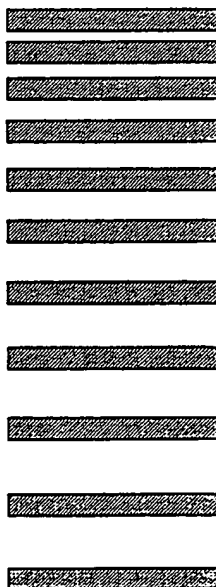

Figure 6

Figure 7

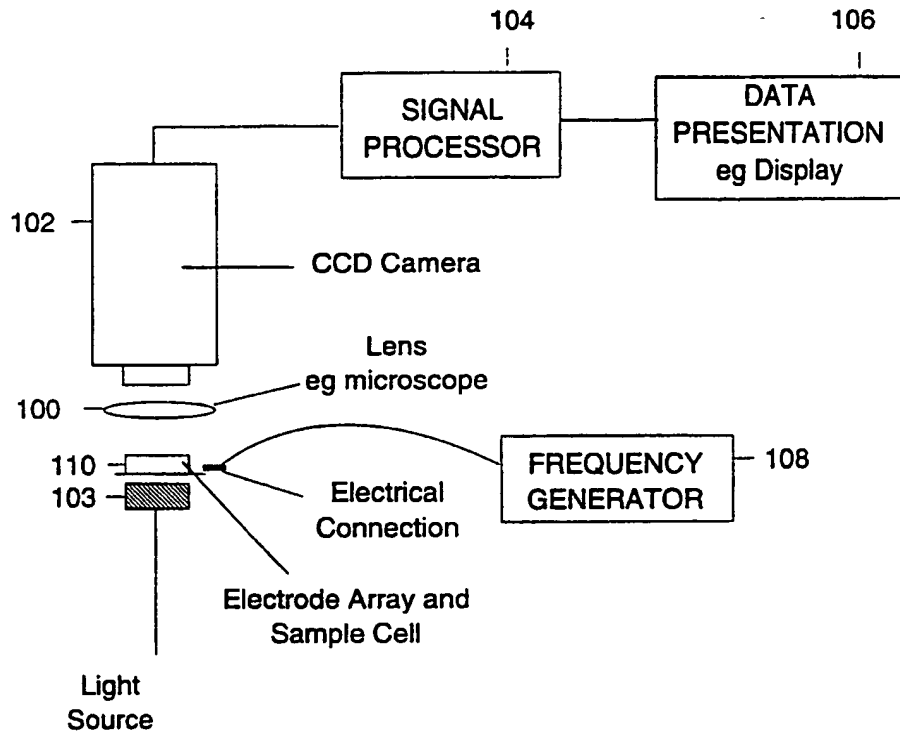

Figure 8

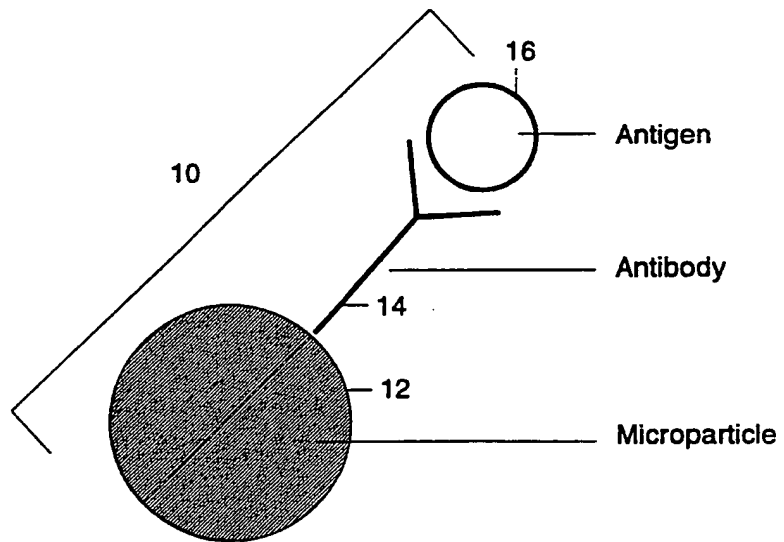

Figure 9

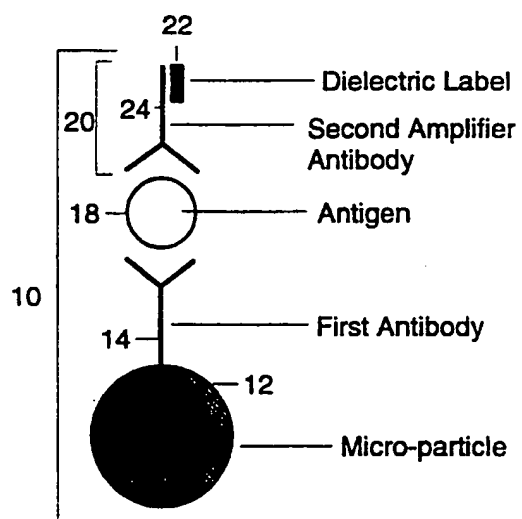

Figure 10

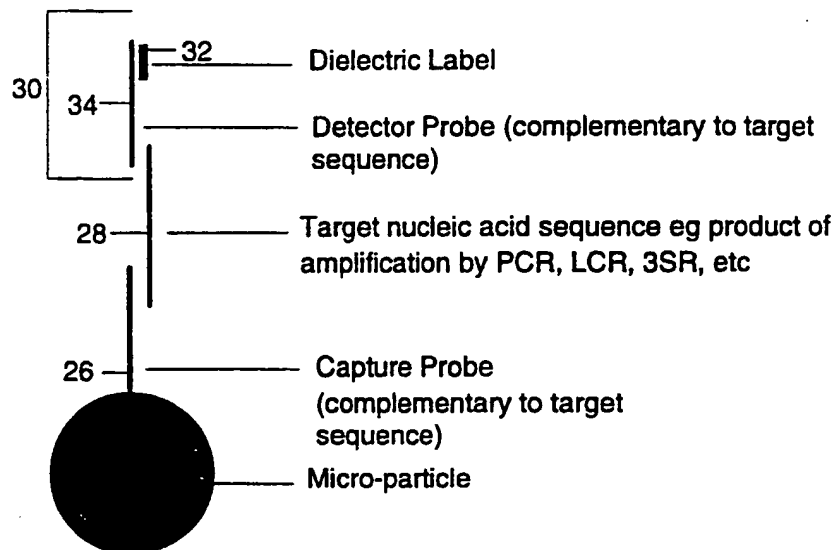

Figure 11

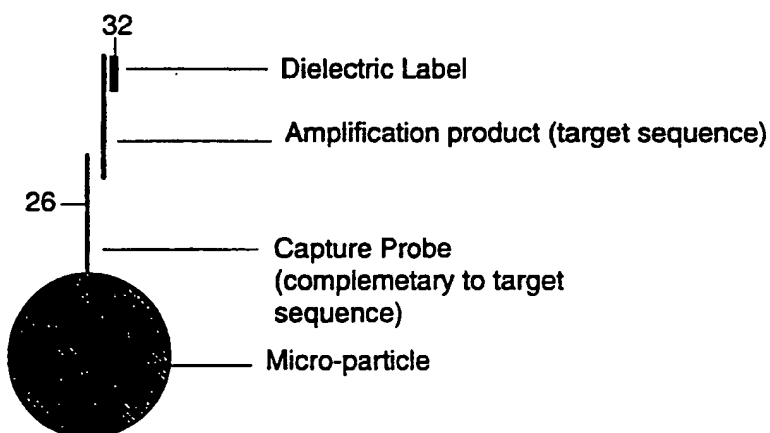
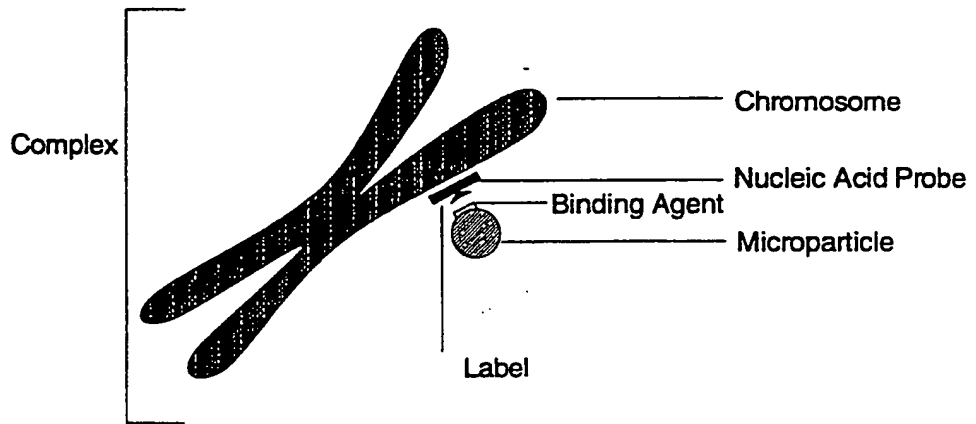

Figure 12 (not to scale)





9712

Figure 13

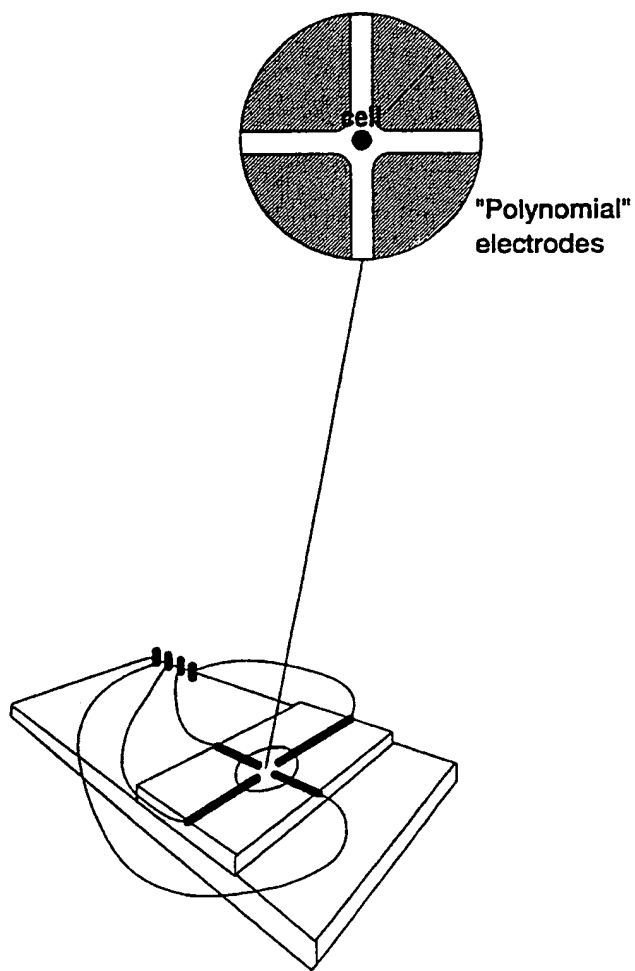

Figure 14

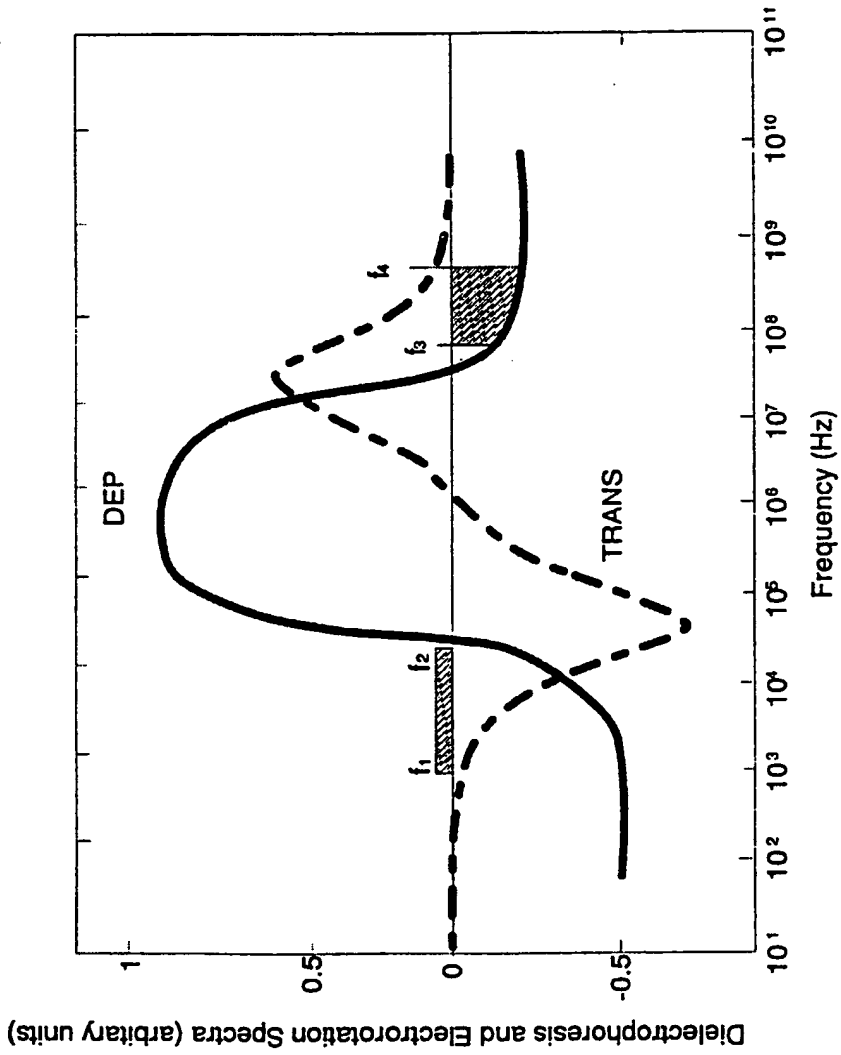

Figure 15

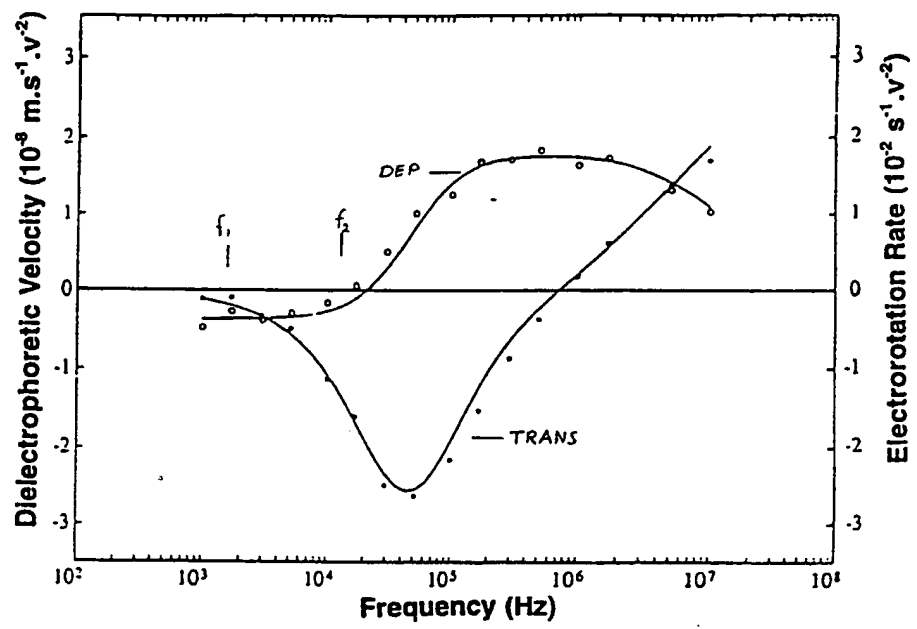
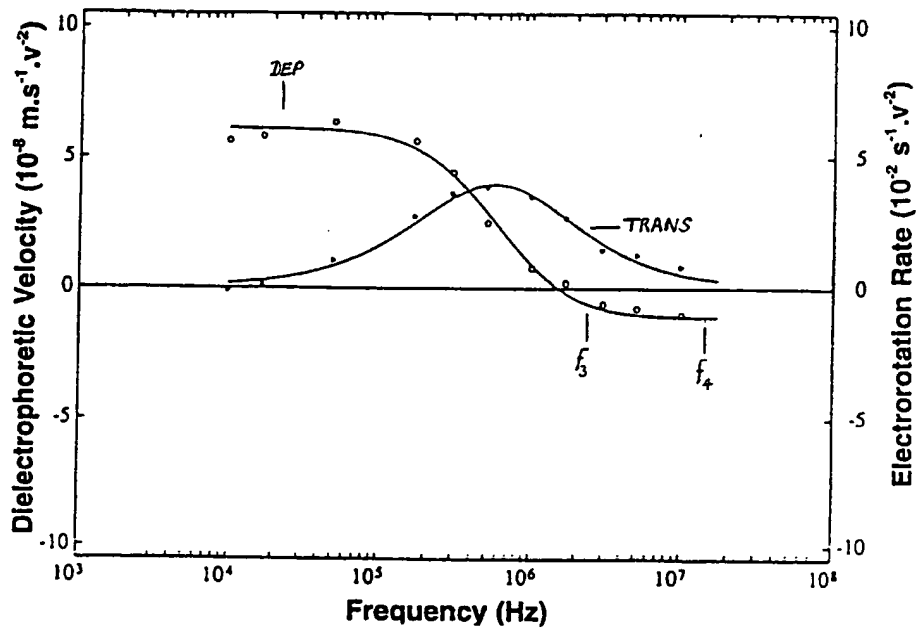

Figure 16



# INTERNATIONAL SEARCH REPORT

International application No.  
PCT/GB 94/00121

**A. CLASSIFICATION OF SUBJECT MATTER**  
IPC 5 B03C5/02 G01N33/58

According to International Patent Classification (IPC) or to both national classification and IPC

**B. FIELDS SEARCHED**

Minimum documentation searched (classification system followed by classification symbols)  
IPC 5 B03C G01N

Documentation searched other than minimum documentation to the extent that such documents are included in the fields searched

Electronic data base consulted during the international search (name of data base and, where practical, search terms used)

**C. DOCUMENTS CONSIDERED TO BE RELEVANT**

Category *	Citation of document, with indication, where appropriate, of the relevant passages	Relevant to claim No.
Y	JOURNAL OF ELECTROSTATICS vol. 25, no. 1, June 1990, AMSTERDAM NL pages 109 - 123 M.WASHIZU	1,4,5
A	see page 117, paragraph 2; figure 6 see page 120, paragraph 4 - page 121, paragraph 1	3,6
Y	---	
Y	EP,A,0 519 250 (MILES INC.) 23 December 1992 see column 6, line 7 - line 24; claims 1,4,10	1,4,5
A	---	
A	US,A,4 390 403 (J.S.BATCHELDER) 28 June 1983 see claim 1	1
	---	
	-/--	

Further documents are listed in the continuation of box C.

Patent family members are listed in annex.

\* Special categories of cited documents :

- "A" document defining the general state of the art which is not considered to be of particular relevance
- "E" earlier document but published on or after the international filing date
- "I" document which may throw doubts on priority claim(s) or which is cited to establish the publication date of another citation or other special reason (as specified)
- "O" document referring to an oral disclosure, use, exhibition or other means
- "P" document published prior to the international filing date but later than the priority date claimed

- "T" later document published after the international filing date or priority date and not in conflict with the application but cited to understand the principle or theory underlying the invention
- "X" document of particular relevance; the claimed invention cannot be considered novel or cannot be considered to involve an inventive step when the document is taken alone
- "Y" document of particular relevance; the claimed invention cannot be considered to involve an inventive step when the document is combined with one or more other such documents, such combination being obvious to a person skilled in the art.
- "&" document member of the same patent family

Date of the actual completion of the international search

21 March 1994

Date of mailing of the international search report

30.03.94

Name and mailing address of the ISA

European Patent Office, P.B. 5818 Patentlaan 2  
NL - 2280 HV Rijswijk  
Tel. (+ 31-70) 340-2040, Tx. 31 651 epo nl,  
Fax (+ 31-70) 340-3016

Authorized officer

Decanniere, L

INTERNATIONAL SEARCH REPORT

International application No.  
PCT/GB 94/00121

C.(Continuation) DOCUMENTS CONSIDERED TO BE RELEVANT		
Category	Citation of document, with indication, where appropriate, of the relevant passages	Relevant to claim No.
X	WO,A,92 07657 (FRAUNHOFER GESELLSCHAFT) 14 May 1992 see claims 1,5,6,8; figure 2 ---	11
A	IEEE TRANSACTIONS ON INDUSTRY APPLICATIONS vol. IA-23, no. 3 , May 1987 , NEW YORK US pages 474 - 480 S.MASUDA cited in the application see the whole document ---	1,9
P,X	JOURNAL OF PHYSICS D. APPLIED PHYSICS vol. 26 , 14 September 1993 , LETCHWORTH GB pages 1528 - 1535 Y HUANG ET AL cited in the application see page 1534, column 2, paragraph 2 ---	1
P,X	DE,A,41 27 405 (FRAUNHOFER-GESELLSCHAFT) 25 February 1993 see claims 1,3,4,7-9,12,13,15 -----	1,10,11

1

**INTERNATIONAL SEARCH REPORT**

information on patent family members

International application No.  
PCT/GB 94/00121

Patent document cited in search report	Publication date	Patent family member(s)	Publication date
EP-A-0519250	23-12-92	JP-A- 5188013	27-07-93
US-A-4390403	28-06-83	NONE	
WO-A-9207657	14-05-92	DE-A- 4034697 EP-A- 0555252 JP-T- 6501159	14-05-92 18-08-93 10-02-94
DE-A-4127405	25-02-93	WO-A- 9303850	04-03-93